

Celebrating **70**  
YEARS



**EROS ELEVATORS**™

ESTD 1947

## POWER & PERFORMANCE



PREMIUM SERVICE PROVIDER

### CAR ELEVATORS

- ▶ GEARLESS MACHINE ROOM-LESS
- ▶ GEARLESS MACHINE ROOM
- ▶ HYDRAULIC

## About Us:

**EROS ELEVATORS**, the pioneer of the Indian Elevator Industry was established in 1947, head quartered in Mumbai and with branches in Pune, Bangalore, Ahmedabad, Surat, Nashik, Rajkot, Vapi, & Daman. EROS manufactures, installs, maintains and modernizes a wide range of elevators which includes, Gearless Machine Room-less Elevators for Passenger, Hospital, Home, Automobile & Freight environments.

With a Legacy of over 70 Years in Vertical Transportation, EROS is well known for providing Best Quality Products & Premium Services.

### Our Mission

We are committed to consistently deliver highly engineered, competitive solutions to move passengers and goods within any project. Our service and products add value to the life cycle of buildings and make each ride safe, smooth and reliable.

### Our Vision

To be a commercially strong, customer centric and socially responsible company, we focus on the following core values:

- Our Company and all its employees follow without compromise a Code of Integrity. We are committed to abide by all prevailing laws and honour our commitments to customers and employees.
- Our people are our priority. Their wellbeing, dignity and work-life balance are our concern. We will be the preferred employer in our industry because we empower our employees to become our future leaders.
- Safety of our customers and employees is our first and foremost concern.

Our effort and success will create value for all stake-holders. We always endeavour to bring harmony to our business and natural environments.



## Product Brief:

Car Elevators are designed for vertical movement of cars in residential / commercial buildings, car showrooms, garages, and other areas. Our car elevator provide compact, easy-to-use basement or podium parking solutions for crowded places and high-density areas.

At Eros we offer a wide range of car elevator models, designed for your requirements by our team of experienced professionals.

### 1) Gearless Machine Room-Less

### 2) Gearless Machine Room

### 3) Hydraulic

## Our Strength:

- Innovative designs
- Customized solutions in vertical transportation
- Widest range of products
- Global sourcing – World class manufacturing
- Professional organization with customer centric approach
- Strong network of trained technicians for timely after sales service
- Online ERP driven processes from enquiry - sale - production - installation - maintenance service

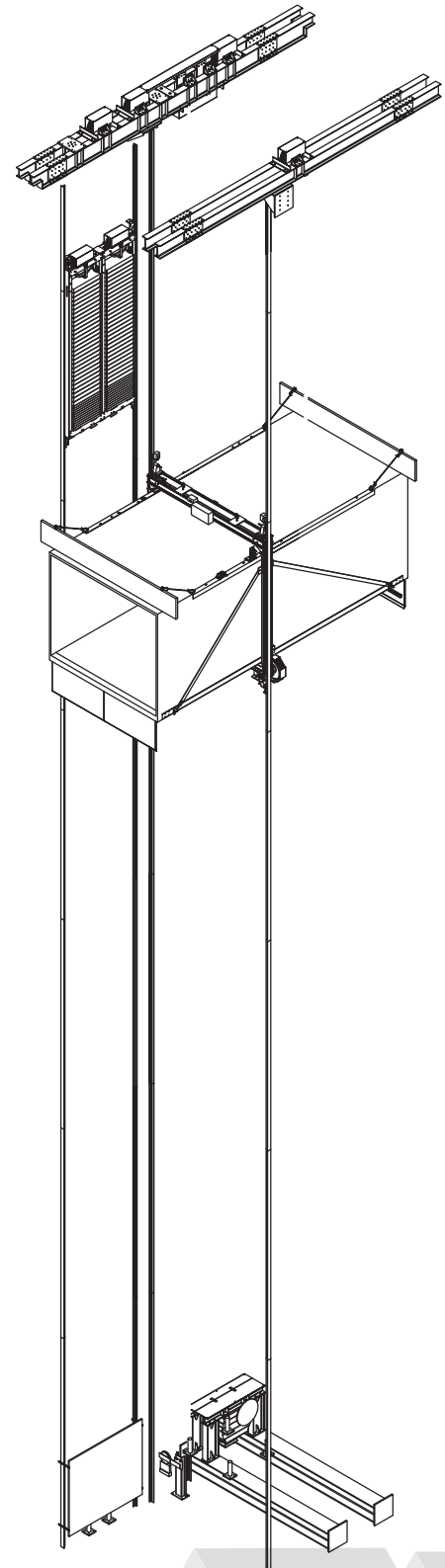



## Installation & Maintenance:



### Installation

- 3- Stage Audit process
- Engineering support at all stages
- Professional Project Management
- Timely installation & handover
- Highly trained & experienced manpower

### Maintenance

- High Serviceable life of Equipment (18-20 Yrs.)
- Highly Skilled Technicians & Engineers
- Dedicated Service Teams
- 24x7 Toll Free Maintenance helpline
- ERP driven online activities (paperless)

## Gearless Traction Machine

- ✓ Green – no gearbox / oil leakage
- ✓ Lower thermal dissipation giving higher efficiency
- ✓ Accurate control across the speed range
- ✓ Wide load range
- ✓ Power Savings
- ✓ Smooth ride & accurate leveling

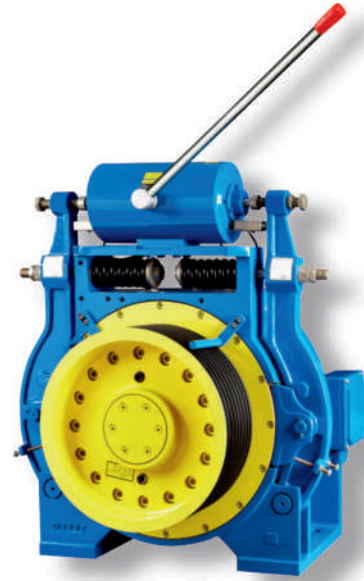

## Hydraulic Pump Unit

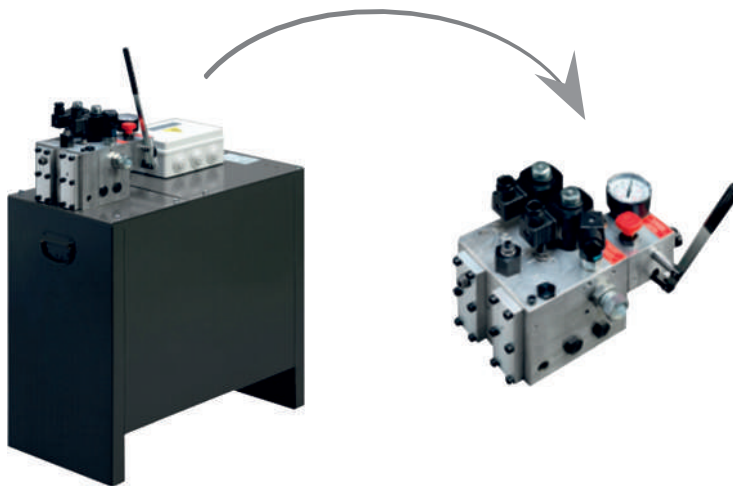

- ✓ Ensures Maximum comfort & silence during travel
- ✓ Low Energy consumption as power is used only in up direction
- ✓ Robust & compact system
- ✓ Easy to install & maintain
- ✓ Requires low overhead space & pit depth
- ✓ Completely imported from Italy

## Car Elevator Cabin Options



### Specifications-

**Car Wall:** Mild Steel Powder Coated

**Ceiling:** Mild Steel Powder Coated with LED lights

**Floor:** MS chequer plate

### Specifications-

**Car Wall:** Stainless Steel Hairline Finish

**Ceiling:** Stainless Steel with LED lights

**Floor:** SS/MS chequer plate



## Door Options

### Vertical

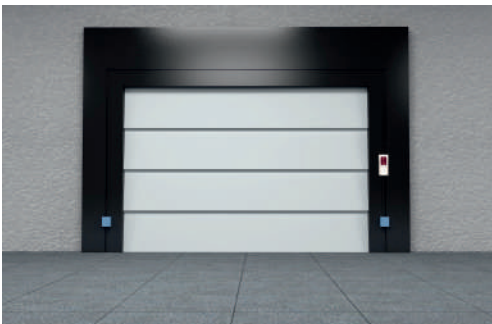

**Door Type:** 4 Panel Vertical telescopic door

**Door Material:** Mild Steel Powder Coated/Stainless Steel

### Horizontal

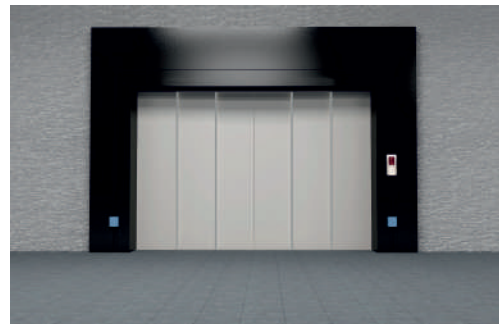

**Door Type:** 6 Panel Centre Bi-parting door

**Door Material:** Mild Steel Powder Coated/ Stainless Steel

## Signalization:



- ▶ Surface Mounted LOP
- ▶ Dot Matrix / LCD Display



- ▶ Standard SS finish
- ▶ Concealed COP
- ▶ Dot Matrix / LCD Display

## Special Sensors:

### RADAR SENSOR:



Only senses cars and cannot be triggered by humans

### THROUGH BEAM SENSOR:



Large openings are possible as emitter & receiver are kept opposite to each other

# Hoistway Layout:

## ERO-11 : HYDRAULIC

Opposite Side Ent Floor

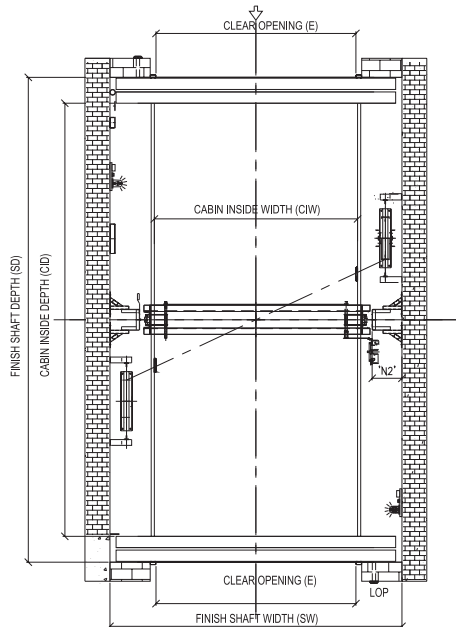

Same Side Ent Floor  
PLAN OF LIFT SHAFT

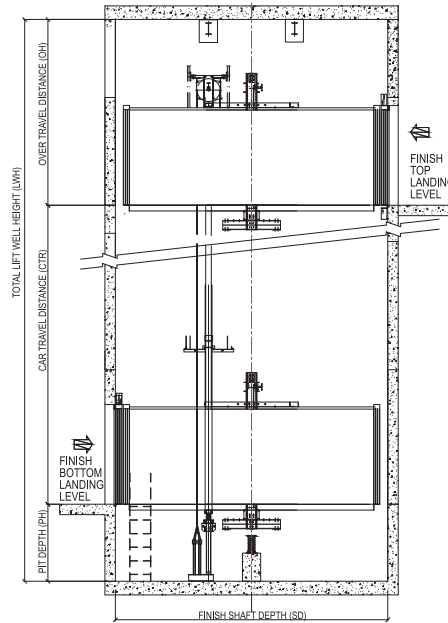

SECTION 'X-X'  
SHAFT ELEVATION

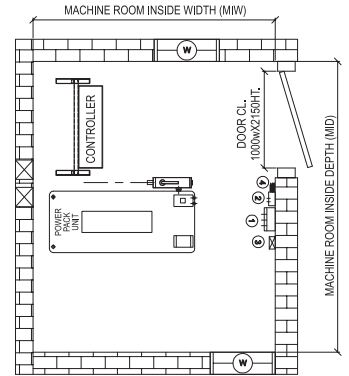

MACHINE ROOM VIEW

## ERO-10 : MRL (Machine in-pit)

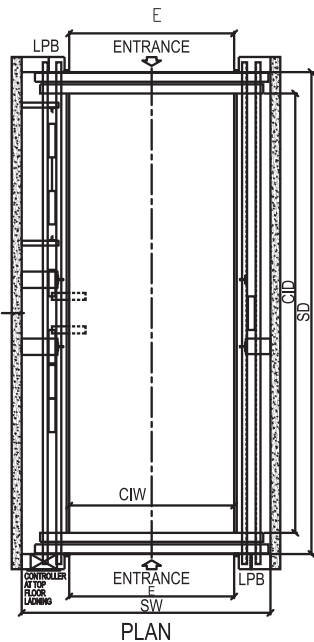

PLAN

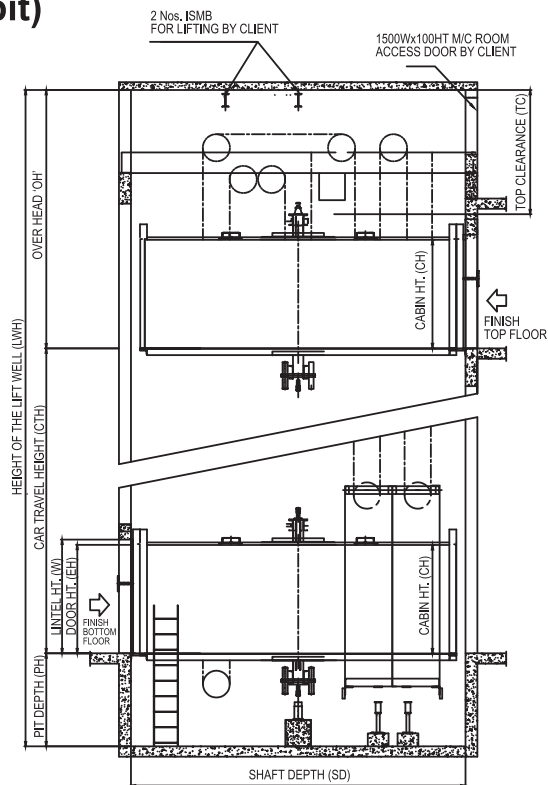

ELEVATION



**CAR LIFT WITH MACHINE ROOM (ERO-10 MR)**

LOAD	SPEED M/s	LIFT SHAFT		CAR INSIDE		ENTRANCE (E X H)	MACHINE ROOM			PIT DEPTH	OH
CAPACITY (KGS.)		SW	SD	CIW	CID		MIW	MID	MH		
2500 ; 3000	0.5 Or 1.0	3250	5925	2250	5500	2250 x 2300	3850	5925	2700	1600	4800
		3350	5925	2300	5500	2300 x 2300	3950	5925	2700		
		3450	6025	2400	5600	2400 x 2300	4050	6025	2700		
		3550	6125	2500	5700	2500 X 2300	4150	6125	2700		

**CAR LIFT MACHINE ROOM-LESS GEARLESS (ERO-10 MRL-MACHINE IN PIT)**

LOAD	SPEED M/s	LIFT SHAFT		CAR INSIDE		ENTRANCE (E X H)	PIT DEPTH	OVERHEAD
CAPACITY (KGS.)		SW	SD	CIW	CID			
3000 to 4000	0.5 Or 1.0	3750	6125	2500	5700	2500 x 2300	2500	5000
		3900	6625	2600	6000	2600 x 2300		
		4100	6625	2800	6000	2800 x 2300		

**CAR LIFT MACHINE ROOM-LESS GEARLESS (ERO-10 MRL-Machine on Top)**

LOAD	SPEED M/s	LIFT SHAFT		CAR INSIDE		ENTRANCE (E X H)	PIT DEPTH	OVERHEAD
CAPACITY (KGS.)		SW	SD	CIW	CID			
2500 to 3000	0.5 Or 1.0	3550	5925	2300	5500	2300 X 2300	1800	5000
		3750	6125	2500	5700	2500 X 2300		
		4100	6625	2800	6000	2800 X 2300		

**CAR LIFT HYDRAULIC (ERO-11)**

LOAD	SPEED M/s	LIFT SHAFT		CAR INSIDE		ENTRANCE (E X H)	MACHINE ROOM			PIT DEPTH	OH
CAPACITY (KGS.)		SW	SD	CIW	CID		MIW	MID	MH		
2500	0.2 To 0.5	3170	5925	2250	5500	2250 x 2300	2000	3000	2700	1500	3800
		3320	6025	2300	5600	2300 x 2300	2000	3000	2700		
		3520	6125	2500	5700	2500 x 2300	2000	3000	2700		
3950		6225	2800	5800	2800 X 2300	2500	3000	2700			
3000											

1) All dimensions are in mm & shall be req. in plumb. 2) Above shaft sizes are suitable for 6 Panel Auto Center Bi-Parting door & same side opening. 3) For opposite side opening, Shaft Depth (SD)= Car Depth (CD) + 624mm.

## Be closer to your Car



Freedom from-

- ❖ **Unauthorized access**
- ❖ **Scratches / Dents**
- ❖ **Theft**

*Enhance the  
Value of your  
Property & Enjoy  
the luxury of  
parking  
conveniently*

## Key Clients

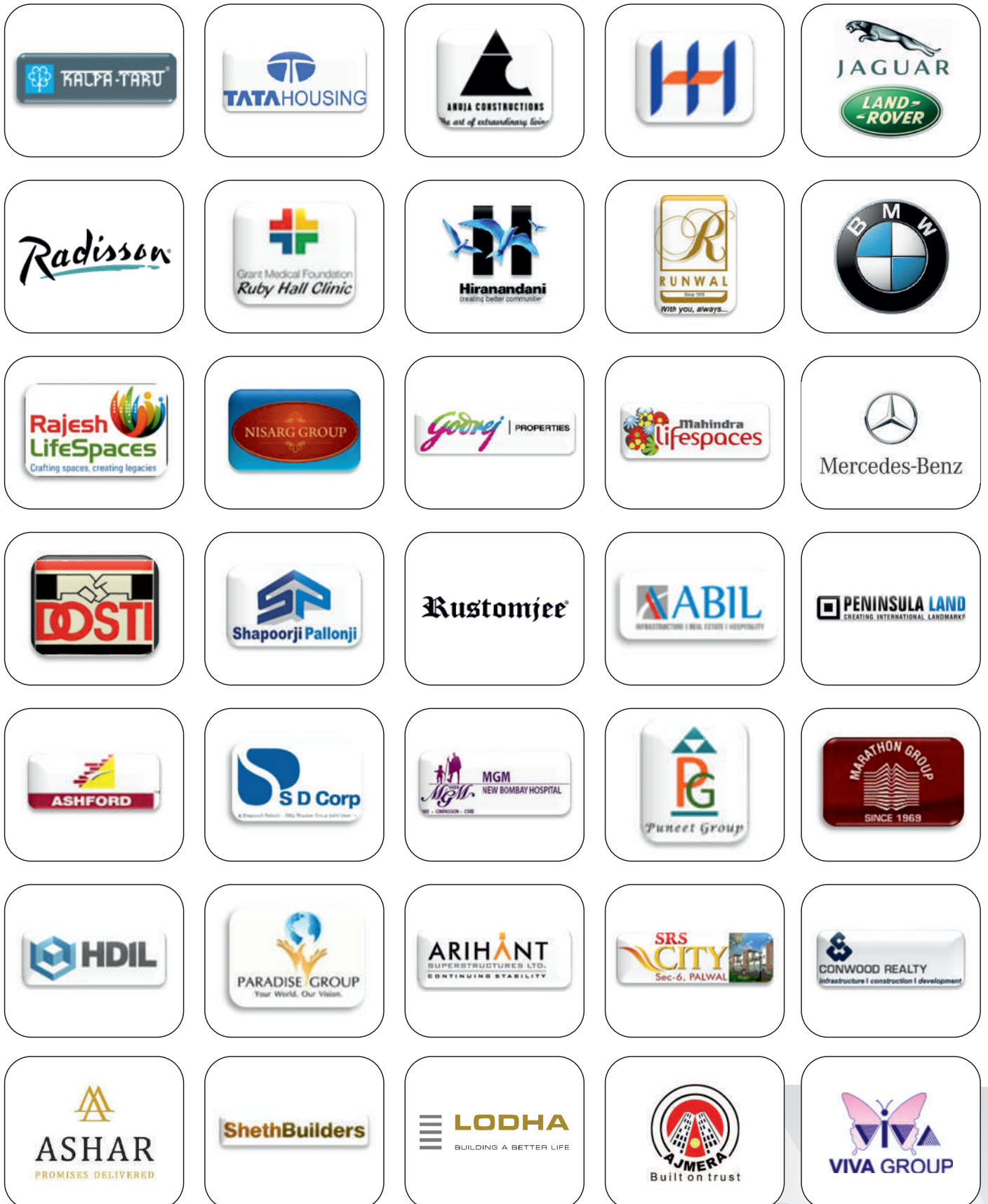

& many many more...

Maintenance Toll Free Number  
**1800 833 0230**

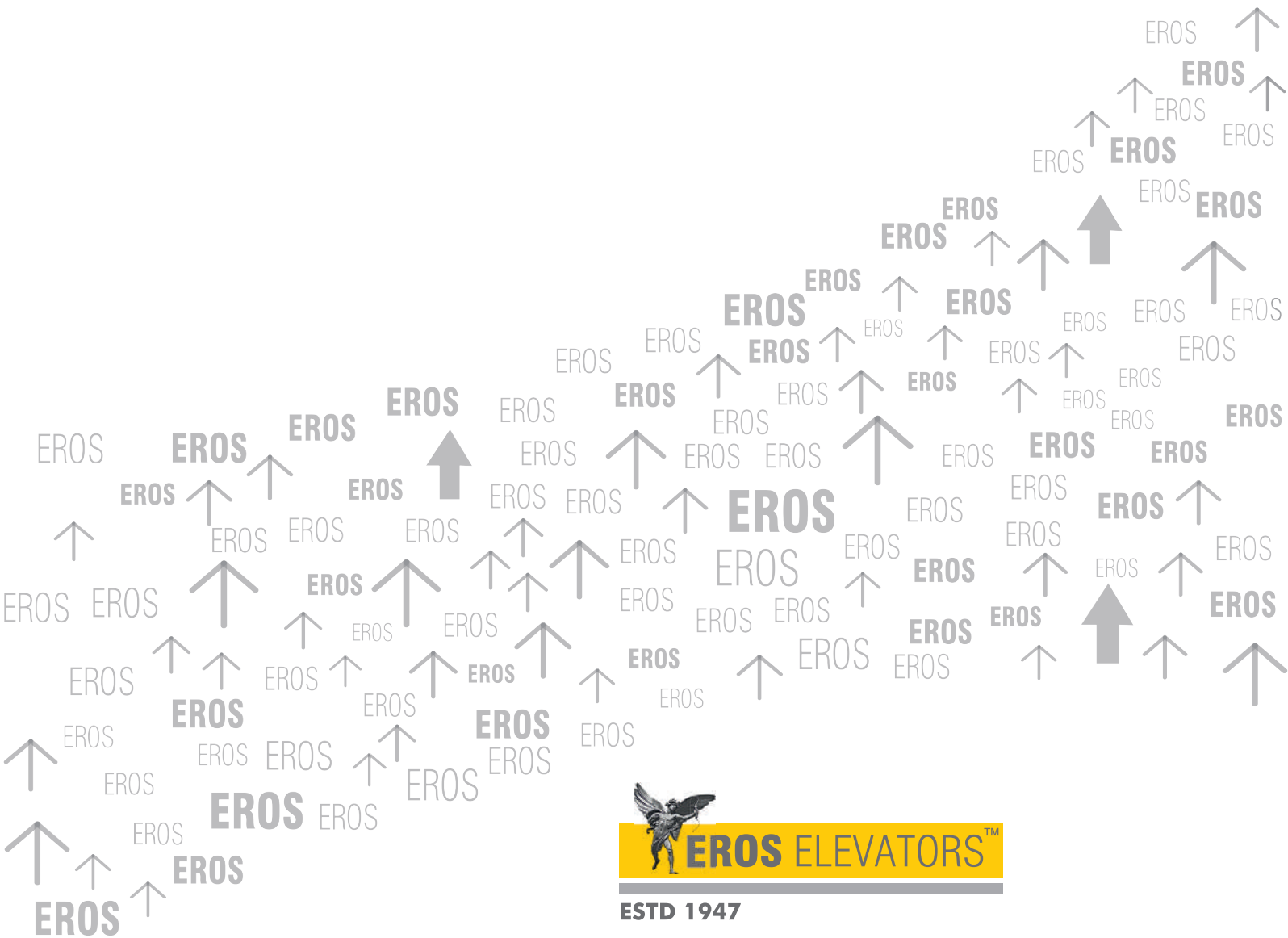

**ESTD 1947**

**EROS ELEVATORS & ESCALATORS PRIVATE LIMITED**

405, Bharat Industrial Estate, T. J. Road,  
Sewree (W), Mumbai - 400 015. INDIA.

Tel.: +91 22 2413 2425, 2414 3431  
Fax : +91 22 2415 3192  
Email : [info@eroselevators.com](mailto:info@eroselevators.com)  
CIN NO. U31909MH2010PTC200179

<http://www.eroselevators.com>

Note : Because of restrictions in printing technology, there will be slight difference between colors in this catalogue & actual.  
The brochure is only for your reference. Please refer to the respective technical documents as items may change due to continuous improvement.